

AEC 12 FLOODLIGHT

Floodlight LED | Indoor | Outdoor

White | Colors | RGBW

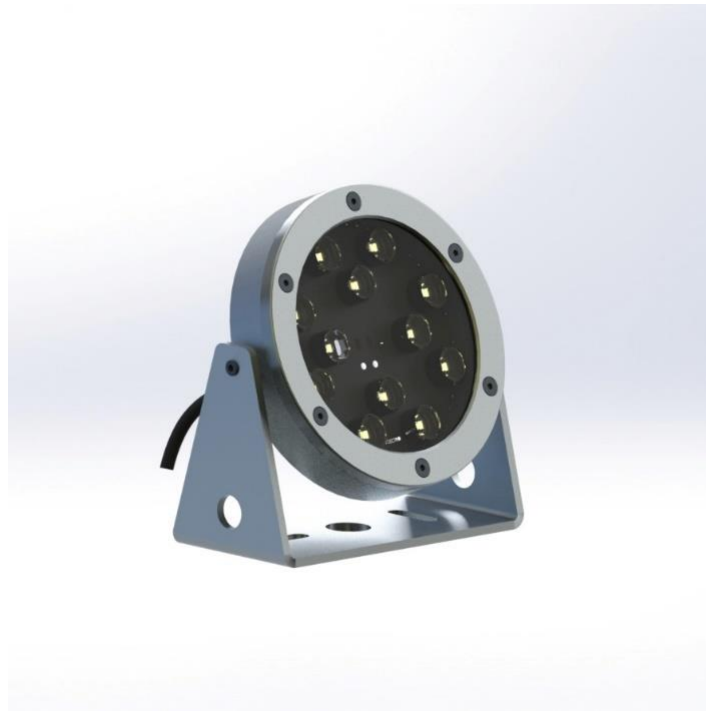

Waterproof floodlight that integrates 12 Power LEDs in an anodized aluminum or 316L stainless steel body. With its specific optics, it provides an extensive or intensive monochromatic luminous flux according to the applications

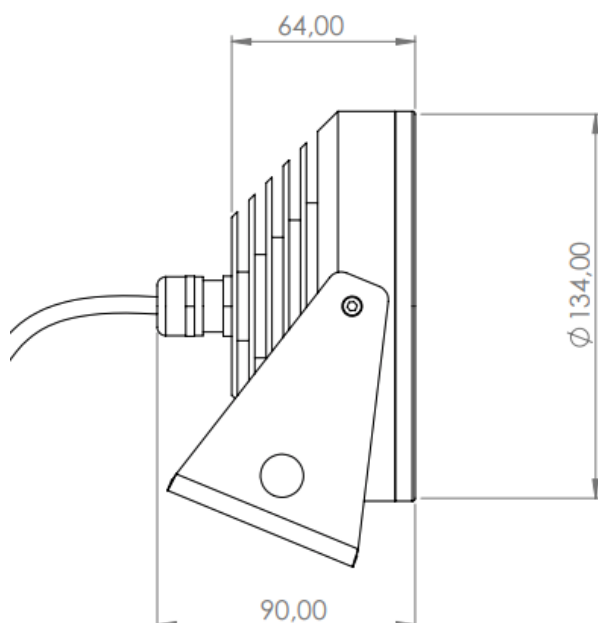

APPLICATIONS:

- Architectural lighting
- Functional lighting

AEC 12 FLOODLIGHT

Floodlight LED | Indoor | Outdoor

Technical data	AEC12
Dimensions	H90mm x ø134mm
Number of LED	12
Power	25W
Luminous flux	3000 lumens (white)
Materials	Anodized aluminum or 316L stainless steel body and polycarbonate glass
Color	White Blue Red Green RGBW
Color temperature	2700K 3000K 4000K 5600K 6500K
Angle	10° to 120°
Lifespan	50 000 hours L 70
operating temperature	-20°C to +45°C
Tension	24Vcc
Optional dimming	DMX PWM Tension
Electrical class	Class III
Connection	Câble L = 1m 2x1mm ²
IK	IK10
IP	IP67
Attachment	Anodized aluminum or stainless steel 2-point adjustable mounting bracket
Compliance	CE NF-EN 60598
Glow Wire Test	850°C
Warranty	5 years
Place of manufacture	France

Données photométriques +/- 10%, le fabricant se réserve le droit de modifier les caractéristiques sans préavis